



Air Vane Motors for Special Applications

Drilling motors | Milling motors | Grinding motors

Air Vane Motors for Special Applications

- **Robust and precise bearing**
- **High running accuracy**
- **High precision drill chucks and collets**

High performance drive for installation in robots and machines.
For example their slim design allows the smallest of drill spacings when applying a multi-spindle technique, such as for the construction of windows.
The robust steel housing guarantees high precision and operational safety.

All air motors can also be used without lubrication.

Drilling motor

Drill motors in slim design allow narrow hole spacing in multiple spindle units such as required for window manufacturing.

Available power classes:

From 80 W - 600 W

Speed range:

150 - 24,000 rpm

Your advantage of the drilling motor:

- Highly accurate drill chuck with taper attachment



Milling motor

The durable milling motors with a superior run-out precision, are the first choice for robotic applications since they are small in size but powerful at a vast speed range.

Available power classes:

400 W

Speed range:

Max. 20,000 rpm (according to your individual application)

Your advantages of the milling motor:

- Robust and precise bearing
- High running precision

Grinding motor

The DEPRAG grinding motor program benefits from decades of experience with the tried and tested DEPRAG handheld pneumatic grinders. The robust steel housing guarantees high accuracy and operational reliability. Furthermore, the grinder spindle feature extremely precise collets for various shaft diameters and offer a high running accuracy.

Available power classes:

From 150 W - 1,000 W

Speed range:

From 15,300 - 47,000 rpm (according to your individual application)

Your advantages of the grinding motor:

- Highly accurate collet for different shaft diameters
- High running precision



80 W drilling motors with collet / 170 W drilling motors with collet or drill chuck

Motor size 1		right rotation			
Series 104-	Type	104-010-1	104-110-1	104-210-1	104-310-1
with collet	Part no.	302929A	302929B	302929C	302929D
Nominal power	W / HP	80 / 0.11	80 / 0.11	80 / 0.11	80 / 0.11
Nominal speed	rpm	11000	3000	950	650
Speed (idling)	rpm	22000	6000	1900	1300
Nominal torque	Nm / in.lbs	0.06 / 0.5	0.22 / 1.9	0.8 / 7	1.2 / 11
Start torque min.	Nm / in.lbs	0.09 / 0.8	0.33 / 2.9	1.2 / 11	1.8 / 16
Air consumption	m ³ /min / cfm	0.23 / 8	0.23 / 8	0.23 / 8	0.23 / 8
Length A2	mm / in.	96.5 / 3.76	96.5 / 3.76	105.5 / 4.11	105.5 / 4.11
Length A1	mm / in.	84.5 / 3.295	84.5 / 3.295	93.5 / 3.646	93.5 / 3.646
Weight	kg / lbs	0.2 / 0.4	0.2 / 0.4	0.22 / 0.5	0.22 / 0.5
Hose I.D.	mm / in.	4 / ⁵ / ₃₂	4 / ⁵ / ₃₂	4 / ⁵ / ₃₂	4 / ⁵ / ₃₂
for drilling steel up to	Ø mm / in.	–	3 / ¹ / ₈	3 / ¹ / ₈	3 / ¹ / ₈
for drilling aluminium up to	Ø mm / in.	3 / ¹ / ₈	3 / ¹ / ₈	3 / ¹ / ₈	3 / ¹ / ₈

Performance data relate to an air pressure of 6 bar (85 PSI) and lubricated air. With oil-free operation the output will be reduced by 10 - 20%.

Motor housing made from stainless steel.
Spindle and collet regular steel.

Motor size 2		right rotation					
Series 104-	Type	104-020-1	104-120-1	104-220-1	104-320-1	104-420-1	104-520-1
with collet	Part no.	302916A	302916B	302916C	302916D	302916E	302916F
Series 104-	Type	–	104-120	104-220	104-320	104-420	104-520
for drill chuck	Part no.	–	302912B	302912C	302912D	302912E	302912F
Nominal power	W / HP	170 / 0.23	170 / 0.23	170 / 0.23	170 / 0.23	170 / 0.23	170 / 0.23
Nominal speed	rpm	12000	3000	2000	750	500	330
Speed (idling)	rpm	24000	6000	4000	1500	1000	660
Nominal torque	Nm / in.lbs	0.13 / 1.1	0.5 / 4.4	0.8 / 7	2.1 / 18	3.2 / 28	4.9 / 43
Start torque min.	Nm / in.lbs	0.19 / 1.7	0.8 / 7	1.2 / 10	3.2 / 28	4.8 / 42	5 / 44*)
Air consumption	m ³ /min / cfm	0.3 / 11	0.3 / 11	0.3 / 11	0.3 / 11	0.3 / 11	0.3 / 11
Weight	kg / lbs	0.38 / 0.84	0.38 / 0.84	0.38 / 0.84	0.43 / 0.95	0.43 / 0.95	0.43 / 0.95
Hose I.D.	mm / in.	6 / ¹ / ₄	6 / ¹ / ₄	6 / ¹ / ₄	6 / ¹ / ₄	6 / ¹ / ₄	6 / ¹ / ₄
for drilling steel up to	Ø mm / in.	–	3 / ¹ / ₈	4 / ⁵ / ₃₂	4 / ⁵ / ₃₂	4 / ⁵ / ₃₂	4 / ⁵ / ₃₂
for drilling aluminium up to	Ø mm / in.	4 / ⁵ / ₃₂	5 / ¹³ / ₆₄	6 / ¹⁵ / ₆₄	6 / ¹⁵ / ₆₄	6 / ¹⁵ / ₆₄	6 / ¹⁵ / ₆₄

Performance data relate to an air pressure of 6 bar (85 PSI) and lubricated air. With oil-free operation the output will be reduced by 10 - 20%.

*) max admissible torque
External parts regular steel.

Optional Equipment	for Motor size 1	for Motor size 2
2 Slide connectors (M8 x 0.75)	included in delivery	–
Noise level at standard version	95 dB (A)	73 dB (A)
with exhaust air system and exhaust filter	71 dB (A)	74 dB (A)
Exhaust air system	Part no. 446354A	302923A
Exhaust filter	Part no. integrated in exhaust air system	8110912
Maintenance unit with lubricator*	Part no. 820454A	820454A
Connection thread	Part no. G ¹ / ₄	G ¹ / ₄
Maintenance unit without lubricator*	Part no. 822408A	822408A
Connection thread	Part no. G ¹ / ₄	G ¹ / ₄
Replacement part set consisting of vanes, sealant rings, o-rings and silencers	Part no. 446085B	446086B
Only suitable for series 104- with collet		
Collet Ø 2 mm	Part no. 314693	312679
Ø 3 mm	Part no. (included in delivery)	312681
Ø 4 mm	Part no. 3024741	312684
Ø 5 mm	Part no. –	312686
Ø 6 mm	Part no. –	included in delivery
Ø 3/32" (2.35 mm)	Part no. 314694	313742
Ø 1/8" (3.175 mm)	Part no. 314407	312682
Ø 1/4" (6.35 mm)	Part no. –	312689
Only suitable for series 104- for drill chuck		
Gear rim drill chuck		
Range 0.5 - 6.5 mm / B 10	Part no. –	804655
Quick change chuck		
Range 0 - 6.5 mm / B 10	Part no. –	805986
(not suitable for type 104-020-1)		

*) Maintenance unit consists of pressure regulator valve, filter and optionally with or without lubricator

Motor size 1
Series 104-
right rotation

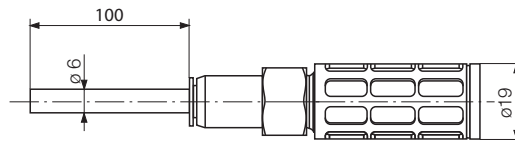
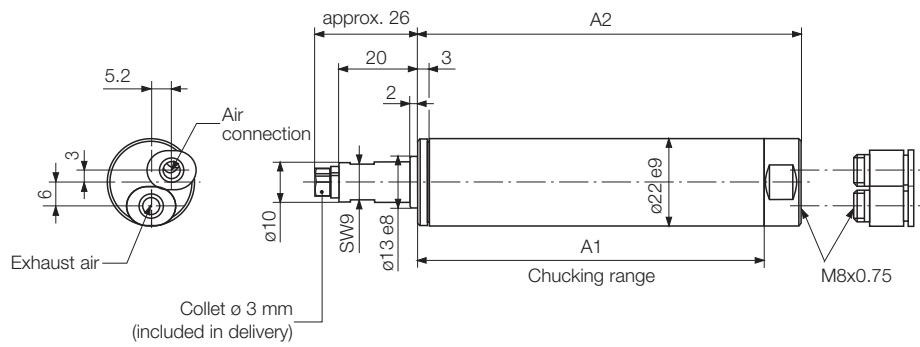

Exhaust air system with integrated silencer 446354A
(optional equipment)

Dimensions in mm

p203439

Motor size 2
Series 104-
right rotation

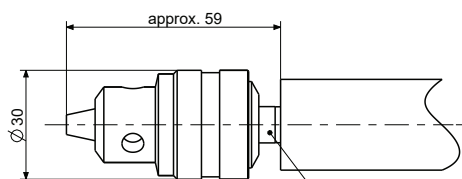
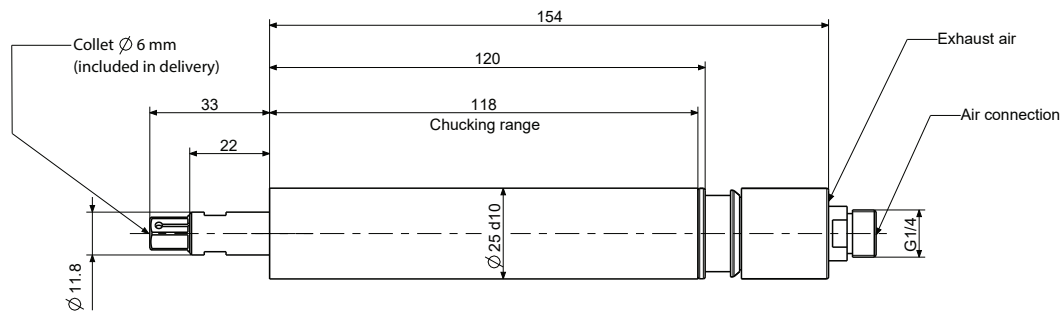

Optional equipment:
804655 Gear rim drill chuck
0-6.5mm / B10

Cone for drill chuck
DIN 238 - B 10
0.5 - 6.5 mm

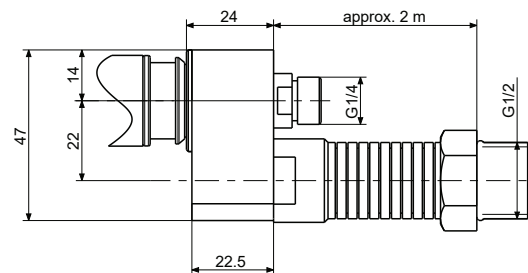

Optional equipment:
302923A Exhaust connection

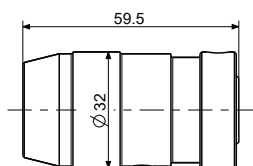

Optional equipment:
805986 Quick change chuck
0-6.5mm / B10

Dimensions in mm

p122581

250 W / 400 W drilling motors with collet or drill chuck

Motor size 2.5		right rotation					
Series 104- with collet	Type Part no.	104-0250-1 302897A	104-1250-1 302897B	104-2250-1 302897C	104-7250-1 302897D	104-3250-1 302897E	104-4250-1 302897F
Series 104- for drill chuck	Type Part no.	104-0250 302900A	104-1250 302900B	104-2250 302900C	104-7250 302900D	104-3250 302900E	104-4250 302900F
Nominal power	W / HP	250 / 0.33	250 / 0.33	250 / 0.33	250 / 0.33	250 / 0.33	250 / 0.33
Nominal speed	rpm	8500	2400	1250	700	350	175
Speed (idling)	rpm	17000	4800	2500	1400	700	350
Nominal torque	Nm / in.lbs	0.28 / 2.5	1 / 9	1.9 / 17	3.4 / 30	6.8 / 60	13.6 / 125
Start torque min.	Nm / in.lbs	0.42 / 3.7	1.5 / 13	2.8 / 25	5.1 / 45	10.2 / 90	20.4 / 180
Air consumption	m ³ /min / cfm	0.35 / 12	0.35 / 12	0.35 / 12	0.35 / 12	0.35 / 12	0.35 / 12
Weight	kg / lbs	0.8 / 1.8	0.8 / 1.8	0.8 / 1.8	0.9 / 2	0.9 / 2	0.9 / 2
Hose I.D.	mm / in.	6 / 1/4	6 / 1/4	6 / 1/4	6 / 1/4	6 / 1/4	6 / 1/4
for drilling steel up to	Ø mm / in.	–	4 / 5/32	6 / 15/64	8 / 5/16	10 / 25/64	10 / 25/64*
for drilling aluminium up to	Ø mm / in.	6 / 15/64	6 / 15/64	8 / 5/16	10 / 25/64	–	–

Performance data relate to an air pressure of 6 bar (85 PSI) and lubricated air. With oil-free operation the output will be reduced by 10 - 20%.

*) Motor housing made from stainless steel, air connection and drive shaft regular steel.

Motor size 3		right rotation					
Series 104- with collet	Type Part no.	104-030-5 302980A	104-130-5 302980B	104-230-5 302980C	104-730-5 302980D	*)	*)
Series 104- for drill chuck	Type Part no.	104-030 302937A	104-130 302937B	104-230 302937C	104-730 302937D	104-830 302937E	104-930 302937H
Nominal power	W / HP	400 / 0.54	400 / 0.54	400 / 0.54	400 / 0.54	400 / 0.54	400 / 0.54
Nominal speed	rpm	8500	2400	1250	700	350	200
Speed (idling)	rpm	17000	4800	2500	1400	700	400
Nominal torque	Nm / in.lbs	0.44 / 3.9	1.6 / 14	3 / 26	5.4 / 48	10.5 / 92.9	19 / 168.2
Start torque min.	Nm / in.lbs	0.66 / 5.8	2.4 / 21	4.5 / 40	8.1 / 72	15.7 / 138.9	28.5 / 252.2
Air consumption	m ³ /min / cfm	0.42 / 15	0.42 / 15	0.42 / 15	0.42 / 15	0.42 / 15	0.42 / 15
Weight	kg / lbs	0.82 / 1.8	0.82 / 1.8	0.82 / 1.8	0.92 / 2	1.3 / 2.86	1.37 / 3
Hose I.D.	mm / in.	10 / 3/8	10 / 3/8	10 / 3/8	10 / 3/8	10 / 3/8	10 / 3/8
for drilling steel up to	Ø mm / in.	–	4 / 5/32	6 / 15/64	8 / 5/16	10 / 3/8	10 / 3/8
for drilling aluminium up to	Ø mm / in.	6 / 15/64	6 / 15/64	8 / 5/16	10 / 25/64	10 / 3/8	12 / 15/32

Performance data relate to an air pressure of 6 bar (85 PSI) and lubricated air. With oil-free operation the output will be reduced by 10 - 20%.

Air connection and drive shaft regular steel.
*) Collet version not available due to high torques.

Optional Equipment		for Motor size 2.5	for Motor size 3
		type 104-0/1/2/730	type 104-8/930
Flange incl. cylinder-screws	Part no.	4445305	4445305
Bracket incl. cylinder-screws	Part no.	4445393	4446112
Maintenance unit with lubricator*	Part no.	820454A	820455A
Connection thread		G 1/4	G 1/2
Maintenance unit without lubricator*	Part no.	822408A	822409A
Connection thread		G 1/4	G 1/2
Replacement part set consisting of vanes, sealant rings, o-rings and silencers	Part no.	446087B	446088C
Noise level at standard version			75 dB (A)
with exhaust air system and exhaust filter			73 dB (A)
Exhaust air system	Part no.		388378B
Exhaust filter	Part no.		8110912
Only suitable for series 104- with collet			
Collet Ø 3 mm	Part no.		312681
Ø 4 mm	Part no.		312684
Ø 4.5 mm	Part no.		312685
Ø 5 mm	Part no.		312686
Ø 6 mm			included in delivery
Ø 1/8" (3.175 mm)	Part no.		312682
Ø 1/4" (6.35 mm)	Part no.		312689
Only suitable for series 104- for drill chuck			
Gear rim drill chuck			
Range 0.8 - 10 mm / B 12	Part no.		804650
Range 1.5 - 13 mm / B 12	Part no.		804694
Quick change chuck			
Range 0 - 8 mm / B 12 (not suitable for type 104-0250/104-030)	Part no.		805985

*) Maintenance unit consists of pressure regulator valve, filter and optionally with or without lubricator

Motor size 2.5
Series 104-
right rotation

Motor size 3
Series 104-
right rotation

Flange / Bracket
(Optional Equipment)

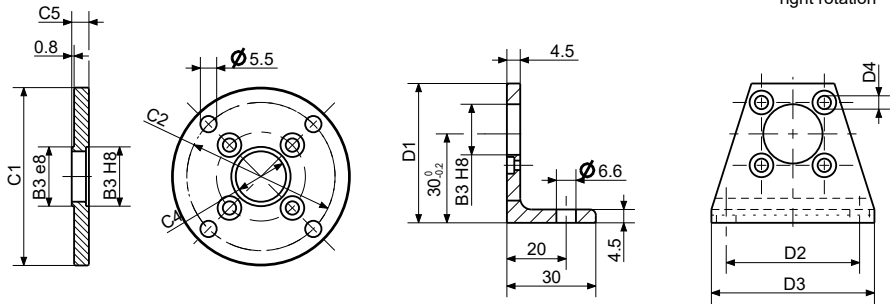

104-0250-1
to
104-4250-1

104-030-5
to
104-730-5

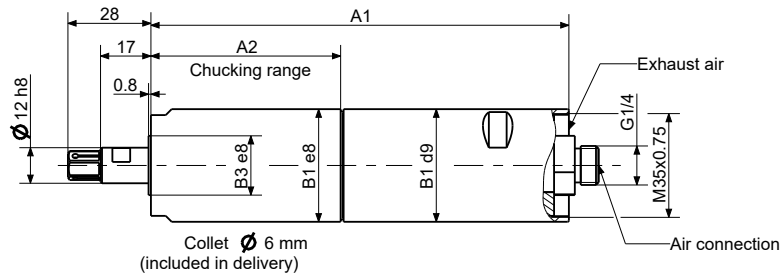

104-0250
to
104-4250

104-030
to
104-730

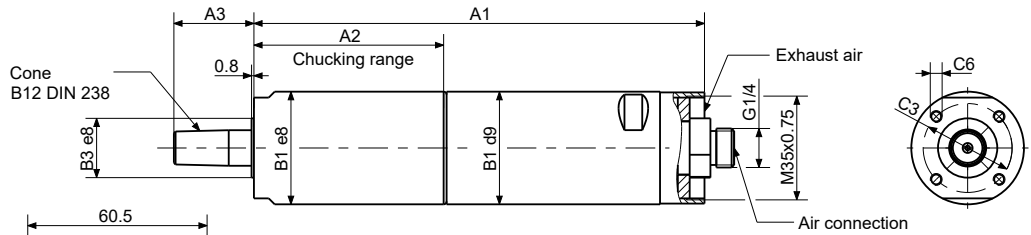

Gear rim drill chuck 804650
0.8 - 10 mm / B12

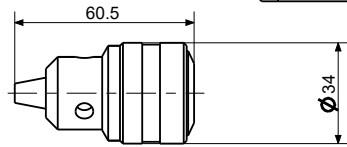

Gear rim drill chuck 804694
1.5 - 13 mm / B12

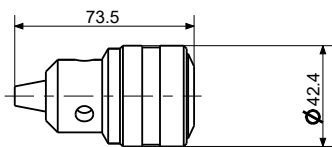

Quick change chuck
805985
0 - 8 mm / B12

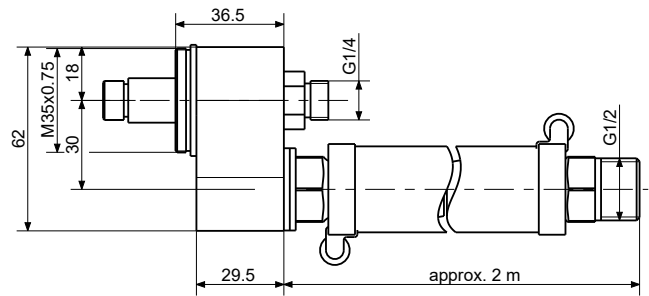
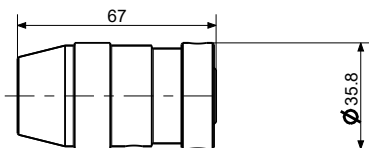

Exhaust air system, part no.: 388378B
Corresponding exhaust filter, part no.: 8110912

Dimensions in mm

p3000771

Motor size	Series 104-Type			Dimensions of motor, bracket and flange (mm)																
				A1	A2	A3	B1	B2	B3	C1	C2	C3	C4	C5	C6	D1	D2	D3	D4	
2.5	104-0250-1	104-1250-1	104-2250-1	141	64	-	-	-	-	-	-	-	-	-	-	-	-	-	-	
	104-7250-1	104-3250-1	104-4250-1	157	80	-	38	34	20	60	50	30	17	5.8	M4	47	45	55	4.5	
	104-0250	104-1250	104-2250	141	64	27	-	-	-	-	-	-	-	-	-	-	-	-	-	-
	104-7250	104-3250	104-4250	157	80	-	38	34	20	60	50	30	17	5.8	M4	47	45	55	4.5	
3	104-030-5	104-130-5	104-230-5	152	64	-	-	-	-	-	-	-	-	-	-	-	-	-	-	
	104-730-5	-	-	168	80	-	38	34	20	60	50	30	17	5.8	M4	47	45	55	4.5	
	104-030	104-130	104-230	152	64	27	-	-	-	-	-	-	-	-	-	-	-	-	-	
	104-730	-	-	168	80	-	38	34	20	60	50	30	17	5.8	M4	47	45	55	4.5	
	104-830	104-930	-	170	82	30	42	36	24	65	55	34	21	6.8	M5	48	50	60	5.5	

300/600 W drilling motors made from stainless steel

Motor size 6		reversible						
Series 67-	Type	67-016B16	67-026B16	67-036B16	67-046B16	67-056B16	67-066B16	67-0661B16
for drill chuck	Part no.	114132H	114132B	114132C	114132D	114132E	114132F	114132G
Nominal power	W / HP	600/0.8	600/0.8	600/0.8	600/0.8	600/0.8	600/0.8	300/0.4
Nominal speed	rpm	2000	1500	1000	350	250	170	90
Speed (idling)	rpm	4000	3000	2000	700	500	340	180
Nominal torque	Nm / in.lbs	2.8/24.78	3.8/33.63	5.7/50.44	16.3/144.3	22.9/202.7	33.7/298.25	31.8/281.43
Start torque min.	Nm / in.lbs	4.3/38.055	5.7/50.445	8.5/75.225	24.5/216.825	34.3/303.55	50.6/447.81	47.7/422.15
Stall torque	Nm / in.lbs	5.4/47.8	7.2/63.72	10.8/95.58	31.1/275.24	43.5/385	64/566.4	60.4/534.54
Air consumption	m ³ /min / cfm	0.85/30	0.85/30	0.85/30	0.85/30	0.85/30	0.85/30	0.55/19.4
Weight	kg / lbs	2.3/5.06	2.3/5.06	2.3/5.06	2.6/5.72	2.7/5.94	2.7/5.94	2.7/5.94
Hose I.D.	mm / in.	12 / 1/2	12 / 1/2	12 / 1/2	12 / 1/2	12 / 1/2	12 / 1/2	12 / 1/2
for drilling steel up to	Ø mm / in.	3 / 1/8	5 / 13/64	8 / 5/16	13 / 33/64	13 / 33/64	13 / 33/64	13 / 33/64
for drilling aluminium up to	Ø mm / in.	3 / 1/8	5 / 13/64	8 / 5/16	13 / 33/64	13 / 33/64	13 / 33/64	13 / 33/64

Performance data relate to an air pressure of 6 bar (85 PSI) and lubricated air. With oil-free operation the output will be reduced by 10 - 20%.

Optional Equipment	for Motor size 6 Series 67-	
Flange incl. cylinder-screws	Part no.	4446166
Bracket incl. cylinder-screws	Part no.	4446176
Gear rim drill chuck	Part no.	804652
Range 1 - 13 mm / B 16		
Quick change chuck	Part no.	804663
Range 1 - 13 mm / B 16		
Noise level at standard version		104 dB (A)
with silencer		94 dB (A)
with exhaust air system		76 dB (A)
Silencer – motor operates in one direction:		
1 Air connection (right- or left-rotation)		
1 Hose-nozzle	Part no.	410540 (G 3/8)
1 Silencer	Part no.	802671 (G 3/8)
1 Silencer	Part no.	802666 (G 1/2)
Silencer – motor is reversible:		
2 Air connections (right- and left-rotation)		
2 Hose-nozzles	Part no.	410540 (G 3/8)
1 Silencer	Part no.	802666 (G 1/2)
Silencer system – motor operates in one direction	Part no.	440019B
Silencer system – motor is reversible	Part no.	440019A
Maintenance unit with lubricator*	Part no.	820455A
Connection thread		G 1/2
Maintenance unit without lubricator*	Part no.	822409A
Connection thread		G 1/2
Replacement part set consisting of		
vaness, sealant rings, o-rings	Part no.	444787A (for motor type 67-016/026/036/046B16)
and silencers	Part no.	444787B (for motor type 67-056/066/0661B16)

*) Maintenance unit consists of pressure regulator valve, filter and optionally with or without lubricator.
Our standard maintenance units are not ATEX conform. Please contact us if this is a requirement.

Motor size 6
67-016 B16
to
67-0661 B16
reversible

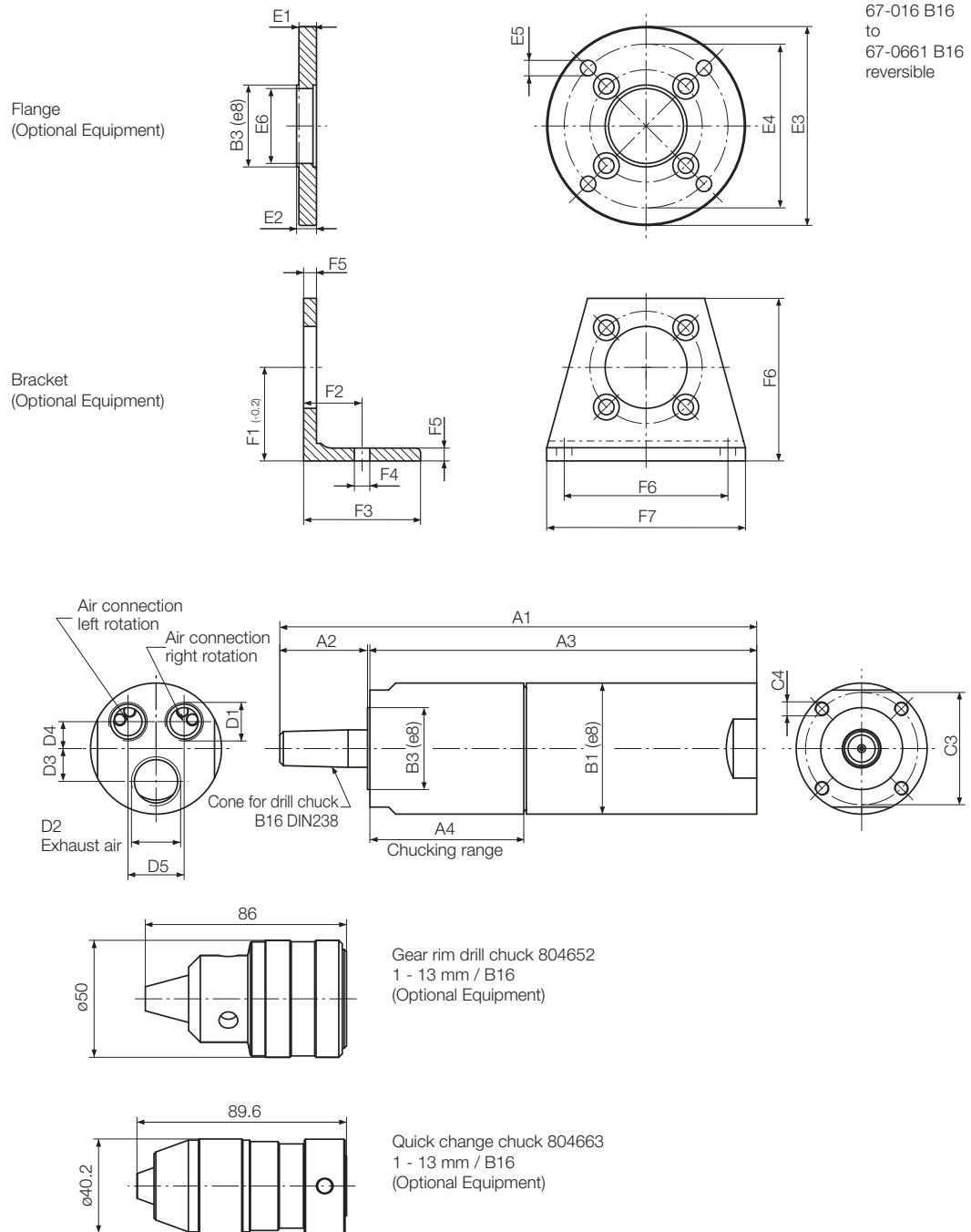

Dimensions in mm

p440183

Motor Size	Series 67- Type			Dimensions of Motor (mm)												
				A1	A2	A3	A4	B1	B3	C3	C4	D1	D2	D3	D4	D5
6	67-016B16	67-026B16	67-036B16	204	37.5	166	66									
	67-046B16			222	37.5	184	84	56	35	48	M6	G ³ / ₈	G ¹ / ₂	14	11.5	24
	67-056B16	67-066B16	67-0661B16	219	38	180	80									

Motor Size	Dimensions Flange Part no. 4446166 (mm)							Dimensions Bracket Part no. 4446176 (mm)							
	B3	E1	E2	E3	E4	E5	E6	F1	F2	F3	F4	F5	F6	D5	
6	35	7.5	8.5	85	70	6.6	32	40	25	50	6.6	5.5	70	85	

150 W / 250 W / 300 W grinding motors

		right rotation			
	Type	211-43	202-30	203-30EA	203-45EA
	Part no.	314740C	315082A	6061173B	6061174B
Nominal power	W / HP	150 / 0.2	250 / 0.33	300 / 0.4	300 / 0.4
Nominal speed	rpm	23,500	16,000	15,000	22,500
Speed (idling)	rpm	47,000	32,000	30,000	45,000
Nominal torque	Nm / in.lbs	0.07 / 0.62	0.15 / 1.33	0.19 / 1.68	0.12 / 1.06
Air consumption (under load)	m ³ /min / cfm	0.23 / 8.1	0.3 / 11	0.45 / 15.9	0.45 / 15.9
Weight	kg / lbs	0.36 / 0.8	0.8 / 1.76	0.7 / 1.54	0.7 / 1.54
Hose I.D.	mm / in.	6 / 1/4	6 / 1/4	6 / 1/4	6 / 1/4
Air inlet pipe thread size		1/4" m	1/4" m	–	–
Max. head-Ø milling insert (high grade steel)	mm / in.	6 / 1/4	10 / ²⁵ / ₆₄	6 / 1/4	6 / 1/4
Max. head-Ø grinding insert	mm / in.	13 / ³³ / ₆₄	25 / 1	20 / ²⁵ / ₃₂	20 / ²⁵ / ₃₂
Max. diameter of the vane disc	mm / in.	15 / ¹⁹ / ₃₂	25 / 1	25 / 1	15 / ¹⁹ / ₃₂
Length of the inlet hose / exhaust hose	m / ft.	–	–	2/1.25 / 6.6/4.1	2/1.25 / 6.6/4.1

Performance data relate to an air pressure of 6 bar (85 PSI) and lubricated air. With oil-free operation the output will be reduced by 10 - 20%.

Included in delivery					
Collet Ø 6 mm	Part no.	312688	312688	830648	830648
Wrench	Part no.	800401	800401	805491	805491
		(9 mm)	(9 mm)	(11 mm)	(11 mm)
Wrench	Part no.	800402	800402		
		(10 mm)	(10 mm)		
Wrench 6/9	Part no.	–	–	830649	830649
Exhaust air system		–	–	✓	✓
Exhaust filter		–	–	✓	✓

Optional Equipment						
Collet	Ø 3 mm	Part no.	312681	312681	830650	830650
	Ø 4 mm	Part no.	312684	312684	830702	830702
	Ø 5 mm	Part no.	312686	312686	830703	830703
	Ø 6 mm		included in delivery	included in delivery	included in delivery	included in delivery
	Ø 1/8" (3.175 mm)	Part no.	312682	312682	830651	830651
	Ø 3/16" (4.76 mm)	Part no.	–	–	830652	830652
	Ø 1/4" mm (6.35 mm)	Part no.	312689	312689	830653	830653
Noise level at version without exhaust air system			85 dB (A)	71 dB (A)	–	–
version with exhaust air system and exhaust filter			73 dB (A)	73 dB (A)	78 dB (A)	79 dB (A)
Exhaust air system	Part no.		334615H	302923B	included in delivery	included in delivery
Exhaust filter	Part no.		8110912	8110912	included in delivery	included in delivery
Maintenance unit with lubricator*	Part no.		820454A	820454A	820454A	820454A
Connection thread			G 1/4	G 1/4	G 1/4	G 1/4
Maintenance unit without lubricator*	Part no.		822408A	822408A	822408A	822408A
Connection thread			G 1/4	G 1/4	G 1/4	G 1/4
Replacement part set consisting of vanes, sealant rings, o-rings and silencers	Part no.		444922A	444921A	440502A	440502A

*) Maintenance unit consists of pressure regulator valve, filter and optionally with or without lubricator

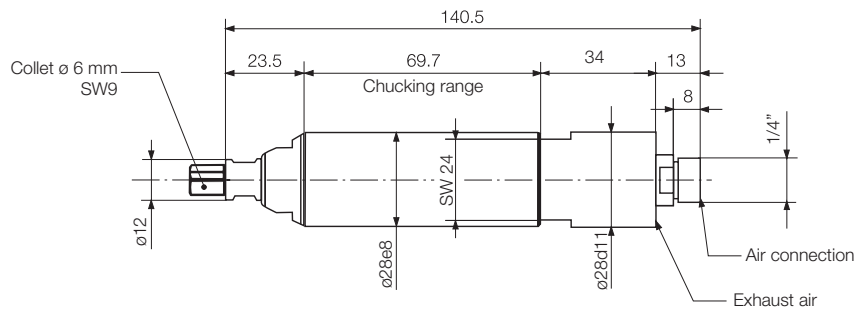

Type 211-43
right rotation

Exhaust air system 334615H (optional equipment) Corresponding exhaust filter 8110912

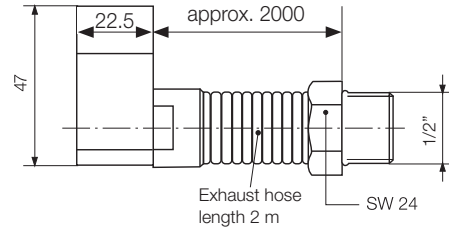

34

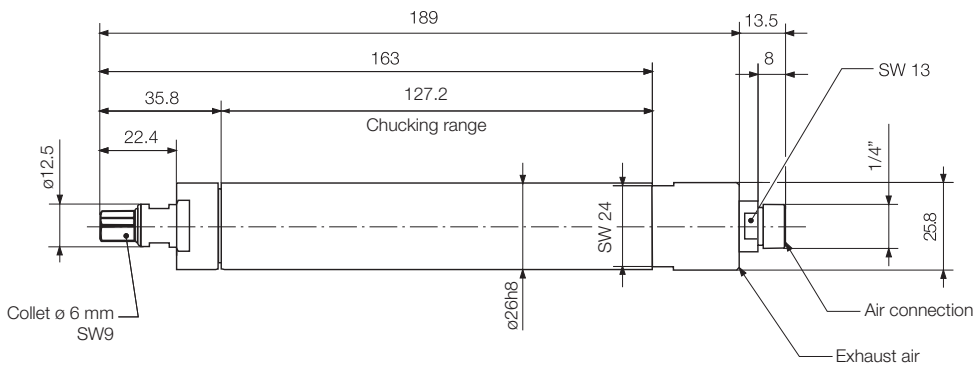

Type 202-30
right rotation

Exhaust air system 302923B (Optional Equipment) Corresponding exhaust filter 8110912

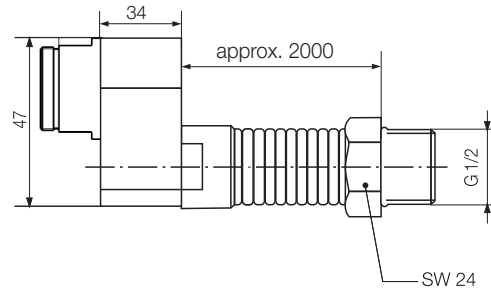

Dimensions in mm

p203428

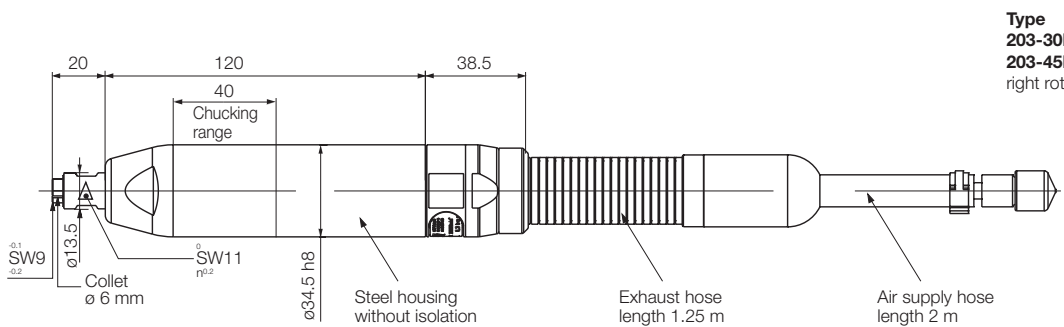

Type 203-30EA 203-45EA
right rotation

Dimensions in mm

m6077877

400 W / 500 W / 700 W / 1000 W milling motors and grinding motors

		right rotation			
Milling motor	Type	27-030	-	-	-
Grinding motors	Type	-	205-20EA	207-19EA	210-15EA
	Part no.	314925A	6061168B	6061169B	6061172B
Nominal power	W / HP	400 / 0.54	500 / 0.67	700 / 0.94	1.000 / 1.34
Nominal speed	rpm	10,000	13,000	13,000	10,500
Speed (idling)	rpm	20,000	20,000	19,000	15,300
Nominal torque	Nm / in.lbs	0.35 / 3.1	0.37 / 3.27	0.51 / 4.5	0.91 / 8.05
Air consumption (under load)	m ³ /min / cfm	0.38 / 13.4	0.9 / 31.8	0.9 / 31.8	1.0 / 35.3
Weight	kg / lbs	0.7 / 1.54	1.2 / 2.64	1.7 / 3.74	1.7 / 3.74
Hose I.D.	mm / in.	10 / ²⁵ / ₆₄	10 / ²⁵ / ₆₄	10 / ²⁵ / ₆₄	12 / ¹⁵ / ₃₂
Aire inlet pipe thread size		¼" m	-	-	-
Max. head-Ø milling insert (high grade steel)	mm / in.	12 / ¹⁵ / ₃₂	16 / ⁵ / ₈	16 / ⁵ / ₈	16 / ⁵ / ₈
Max. head-Ø grinding insert	mm / in.	32 / 1¼	32 / 1¼	40 / ¹³⁷ / ₆₄	50 / ¹³¹ / ₃₂
Max. diameter of the vane disc	mm / in.	-	40 / ¹³⁷ / ₆₄	40 / ¹³⁷ / ₆₄	50 / ¹³¹ / ₃₂
Length of the inlet hose / exhaust hose	m / ft.	-	2/1 6.56/3.28	2/1 6.56/3.28	2/1 6.56/3.28

Performance data relate to an air pressure of 6 bar (85 PSI) and lubricated air. With oil-free operation the output will be reduced by 10 - 20%.

Included in delivery					
Collet Ø 6 mm	Part no.	312694	6014315	315018	315018
Wrench	Part no.	800403	800402	800405	800405
		(12 mm)	(10 mm)	(17 mm)	(17 mm)
Wrench	Part no.	800405	800410	800416	800416
		(17 mm)	(14 mm)	(22 mm)	(22 mm)
Exhaust air system		-	✓	✓	✓
Exhaust filter		-	✓	✓	✓

Optional Equipment						
Collet	Ø 3 mm	Part no.	312690	6014320	6014317	6014317
	Ø 4 mm	Part no.	312692	6014321	6017743	6017743
	Ø 5 mm	Part no.	312693	-	6017744	6017744
	Ø 6 mm		included in delivery	included in delivery	included in delivery	included in delivery
	Ø 7 mm	Part no.	312739	-	-	-
	Ø 8 mm	Part no.	312696	-	315073	315073
	Ø 8 mm (stainless steel)	Part no.	-	-	6014282	6014282
	Ø 9 mm	Part no.	313137	-	315089	315089
	Ø 1/8" (3.175 mm)	Part no.	312691	6014320	-	-
	Ø 3/16" (4.76 mm)	Part no.	-	6014321	315088	315088
Ø 1/4" (6.35 mm)	Part no.	312695	6014314	315074	315074	
Ø 5/16"	Part no.	-	-	315090	315090	
Noise level at version without exhaust air system		75 dB (A)	-	-	-	
version with exhaust air system and exhaust filter		73 dB(A)	79 dB(A)	79 dB(A)	80 dB(A)	
Exhaust air system	Part no.	388378B	included in delivery	included in delivery	included in delivery	
Exhaust filter	Part no.	8110912	included in delivery	included in delivery	included in delivery	
Maintenance unit with lubricator*	Part no.	820454A	820455A	820455A	820455A	
Connection thread		G ¼	G ½	G ½	G ½	
Maintenance unit without lubricator*	Part no.	822408A	822409A	822409A	822409A	
Connection thread		G ¼	G ½	G ½	G ½	
Replacement part set consisting of vanes, sealant rings, o-rings and silencers	Part no.	446088D	440502B	440502C	440502D	

* Maintenance unit consists of pressure regulator valve, filter and optionally with or without lubricator

**Milling motor
Type 27-030
right rotation**

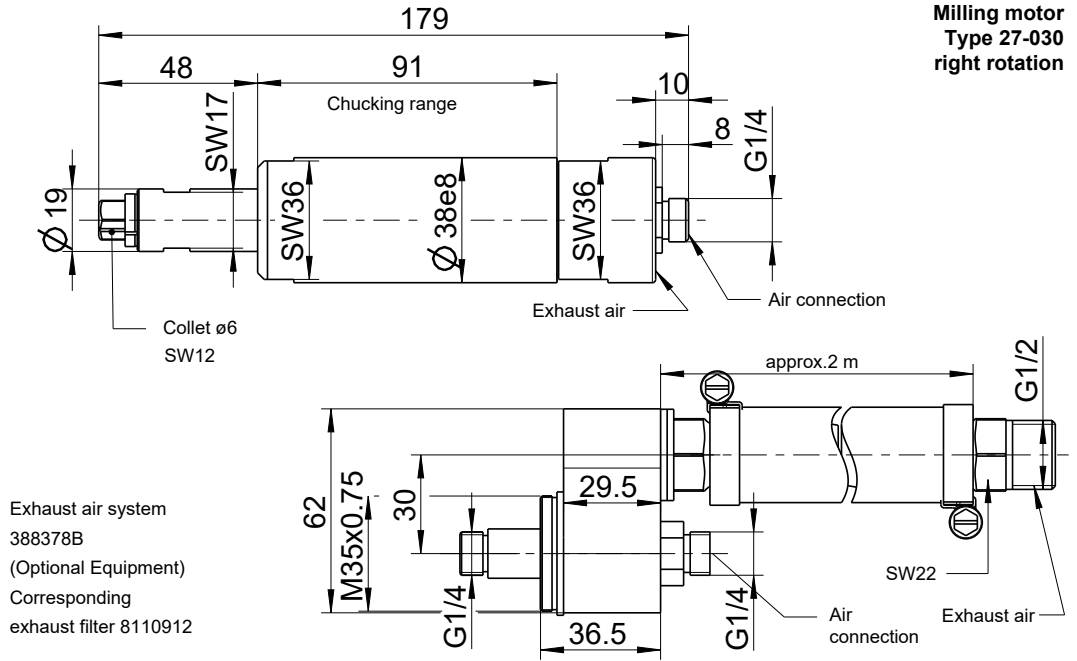

Dimensions in mm

p203428

**Type 205-20EA
right rotation**

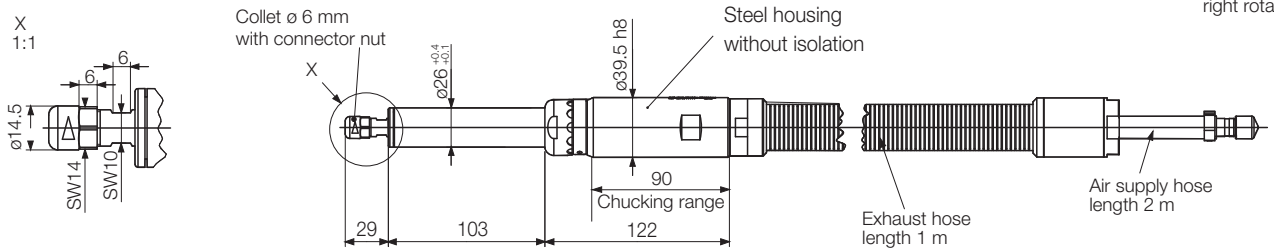

Dimensions in mm

m6077872

**Type 207-19EA
right rotation**

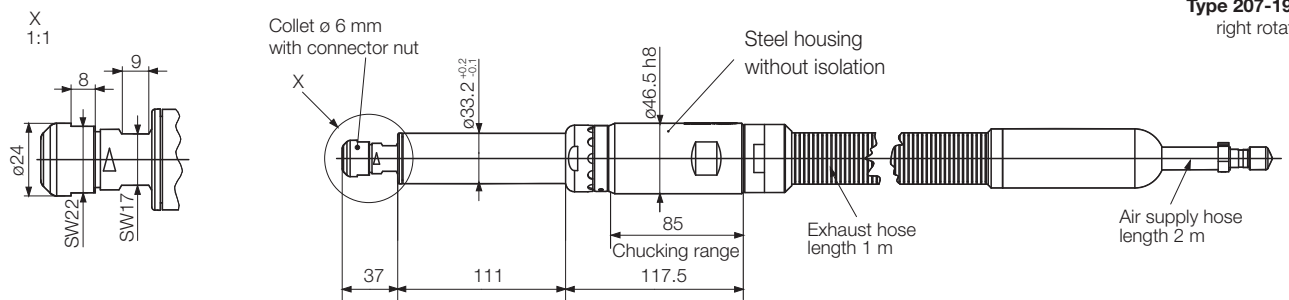

Dimensions in mm

m6077873

**Type 210-15EA
right rotation**

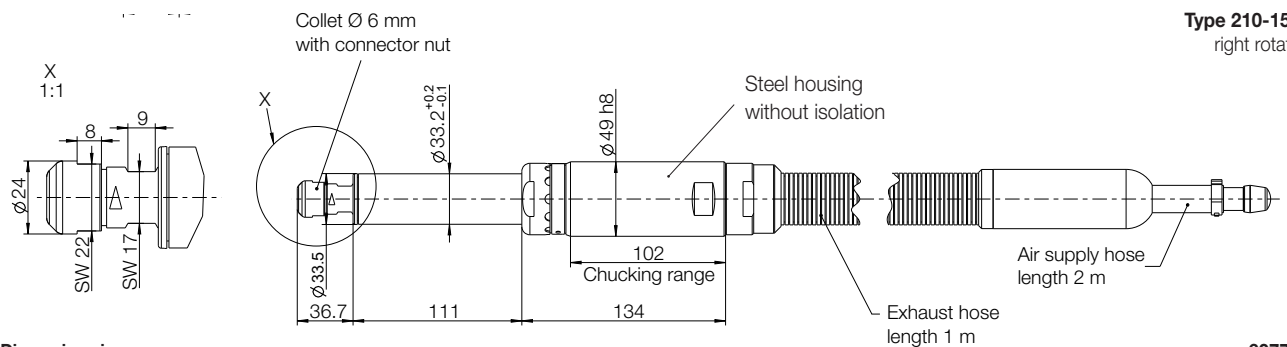

Dimensions in mm

m6077876

Maximum allowable load on the drive shaft

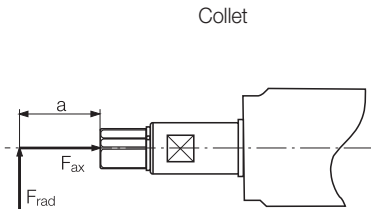

Motors with collet

Typ	Bestell-Nr.	Fax [N]	Frad [N]	a [mm]
104-010-1	302929A	200	75	25
104-110-1	302929B			
104-210-1	302929C			
104-310-1	302929D			
104-020-1	302916A			
104-120-1	302916B			
104-220-1	302916C	380	50	25
104-320-1	302916D			
104-420-1	302916E			
104-520-1	302916F			
104-0250-1	302897A			
104-1250-1	302897B			
104-2250-1	302897C	750	220	25
104-7250-1	302897D			
104-3250-1	302897E			
104-4250-1	302897F			
104-030-5	302980A			
104-130-5	302980B			
104-230-5	302980C	680	510	25
104-730-5	302980D			

Motors with drill chuck

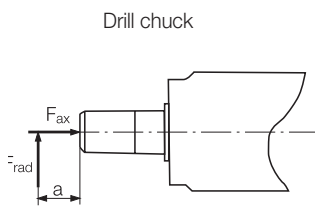

Typ	Bestell-Nr.	Fax [N]	Frad [N]	a [mm]			
104-120	302912B	380	35	60			
104-220	302912C						
104-320	302912D						
104-420	302912E						
104-520	302912F						
104-0250	302900A				750	150	70
104-1250	302900B						
104-2250	302900C						
104-7250	302900D						
104-3250	302900E						
104-4250	302900F						
104-030	302937A						
104-130	302937B						
104-230	302937C						
104-730	302937D						
104-830	302937E	790	265	80			
104-930	302937H						
67-026B16	114132B	1100	265	80			
67-036B16	114132C						
67-046B16	114132D						
67-016B16	114132H						
67-056B16	114132E						
67-066B16	114132F						
67-0661B16	114132G						

Maximum allowable load on the drive shaft

Milling motors and Grinding motors

Type	Part no.	F _{ax} [N]	F _{rad} [N]	a [mm]
203-30EA	6061173B	20	40	25
203-45EA	6061174B			
205-20EA	6061168B			
207-19EA	6061169B			
210-15EA	6061172B			
211-43	314740C	15	30	
202-30	315082A	25	50	
27-030	314925A			

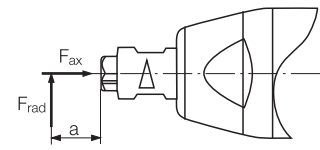

203-30EA / 203-45EA

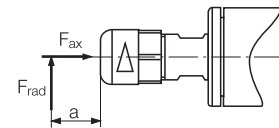

205-20EA

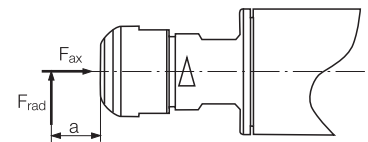

207-19EA / 210-15EA

Speed standard values (rpm) for HSS spiral drills

Cutting Speed	35 m/min (115 ft./min)	28 m/min (90 ft./min)	25 m/min (80 ft./min)	14 m/min (45 ft./min)	11 m/min (35 ft./min)	7 m/min (23 ft./min)	22 m/min (70 ft./min)	12 m/min (40 ft./min)	50 m/min (165 ft./min)	90 m/min (300 ft./min)	165 m/min (540 ft./min)	210 m/min (690 ft./min)
Drill dia. mm/in.	Carbon steel			Alloy steel		Stainless steel	Cast-Iron		Copper Bronze Brass	Leightweight-Metal common alloy hard mid brass ¹⁾		Magnesium-Alloy ²⁾
	up to 500 N/mm ² (30 long tons/ sq. in.)	500 - 700 N/mm ² (30 - 45 long tons/ sq. in.)	above 700 N/mm ² (45 long tons/ sq. in.)	700 - 900 N/mm ² (45 - 55 long tons/ sq. in.)	900 - 1100 N/mm ² (55 - 70 long tons/ sq. in.)		up to 180 N/mm ² (10 long tons/ sq. in.)	above 180 N/mm ² (10 long tons/ sq. in.)				
1/0.04	11000	8800	7800	4400	3400	2200	7000	3800	16000	28000	52000	66000
2 / ¹ / ₆₄	5500	4400	3900	2200	1700	1100	3500	1900	8000	14000	26000	33000
3 / ¹ / ₈	3700	3000	2600	1500	1100	730	2300	1300	5300	9000	17300	22000
4 / ¹ / ₃₂	2800	2200	2000	1100	850	550	1700	950	4000	7000	13000	16500
5 / ¹ / ₆₄	2200	1800	1600	880	680	440	1400	760	3200	5600	10400	13200
6 / ¹ / ₆₄	1900	1500	1300	735	570	365	1200	630	2700	4800	8700	11000
7 / ¹ / ₃₂	1600	1300	1100	630	485	315	1000	540	2300	4000	7400	9400
8 / ¹ / ₁₆	1400	1100	975	550	425	275	875	475	2000	3500	6500	8300
9 / ¹ / ₆₄	1200	975	865	490	380	245	780	420	1800	3100	5800	7400
10 / ¹ / ₆₄	1100	880	780	440	340	220	700	380	1600	2800	5200	6600

1) Speed for machining of thermoset plastics, laminates and hard laminates, however instead of the HSS-drills we recommend high-speed steel drills made with hard-metal K 10
2) for thermoplastics use approx. double the value

Tell us your operational conditions and our application consultants will be happy to help.
Please use the enquiry form below and send it to: airmotors@deprag.de

Application:	
In what kind of environment will the motor be installed?	ATEX requirement / explosion safety? <input type="checkbox"/> yes <input type="checkbox"/> no if yes, which safety class: food industry conformity? <input type="checkbox"/> yes <input type="checkbox"/> no sterilisable? <input type="checkbox"/> yes <input type="checkbox"/> no acid resistant? <input type="checkbox"/> yes <input type="checkbox"/> no steam resistant? <input type="checkbox"/> yes <input type="checkbox"/> no
Application conditions:	constant operation (24 hrs, non-stop) <input type="checkbox"/> yes <input type="checkbox"/> no duty cycle in hrs/day: days/year: cycle time (s): motor loaded to stall? <input type="checkbox"/> yes <input type="checkbox"/> no self-locking? <input type="checkbox"/> yes <input type="checkbox"/> no
Required turn direction:	<input type="checkbox"/> left <input type="checkbox"/> right <input type="checkbox"/> reversible (view from air inlet)
Motor performance:	power: W nominal torque: Nm nominal speed: rpm
Performance influencing application conditions:	operating pressure (at motor inlet): bar operation with lubricated air possible? <input type="checkbox"/> yes <input type="checkbox"/> no smallest opening cross-section of connection pieces and hoses? mm
External motor design:	<input type="checkbox"/> standard steel <input type="checkbox"/> non-corrosive <input type="checkbox"/> aluminium <input type="checkbox"/> plastics <input type="checkbox"/> ceramics other:
Drive spindle design:	drive shaft requirements: (e. g. keyed shafts, square end, hexagonal, collet, drill chuck taper, etc.) required dimensions:
Motor fixture design:	mounting requirements: (bracket, flange, etc.) required dimensions:
Additional components:	<input type="checkbox"/> holding brake <input type="checkbox"/> operational brake gear box:
Price range:	
Annual requirement:	

DEPRAG

DEPRAG SCHULZ GMBH u. CO. KG

P.O. Box 1352 | D-92203 Amberg

Carl-Schulz-Platz 1 | D-92224 Amberg

Phone: +49 9621 371-0 | Fax: +49 9621 371-120

www.deprag.com | info@deprag.de

CERTIFIED AS PER DIN EN ISO 9001
