



Portrol 401

Portable electric equipment
for the controlled tube expansion

Production

Tube rolling



A winning story since 1961

The Beginning

At the end of the 1950s, Domenico Franco Agostino became the Italian representative of Albert Otto, a German manufacturer of tube expanders. In 1961 Franco Agostino's Albert Otto Italiana was founded and in 1972, after purchasing an area of 10,000 square metres in the municipality of Bagnolo Cremasco, Maus Italia Sas was established.

The Growth

In 1976 his son Stefano, a mechanical engineer, joined the company. Together with his father, he studied products, introduced new machinery onto the market and filed the first patents by Maus Italia. Above all, Stefano was firmly convinced that people are the very heart of a company's success. Therefore, he invested in human capital by valuing people and roles, and he surrounded himself with skilled operators as well as technical, commercial and administrative collaborators. The result was a winning, competent and proactive team.

His daughter Anna - also a mechanical engineer - has been working in the company since 2016, giving new impetus and energy to the business her father and grandfather had built.

Father and daughter work together side by side every day to guarantee the excellence of Maus Italia and support all customers worldwide with competence and passion: the company's distinctive traits.



Stefano Agostino
CEO - Mechanical Engineer

Anna Agostino
COO - Mechanical and Management Engineer



In-house production of each component ***Workshop 4.0 and 24/7 production control***

The production of Maus Italia branded items is entirely carried out in Bagnolo Cremasco, in the heart of an Italian industrial area 30 km southeast of Milan.

The company boasts a 4.0 workshop equipped with state-of-the-art machinery, an in-house heat treatment room and a final inspection department that allow Maus Italia to independently manage every phase of the manufacturing process of its wide range of products whilst maintaining high quality standards.



Quality first. ***Design and development***

One of Maus Italia's strengths is its willingness to understand its customers' needs.

Our technical department is always ready to find operational solutions to the most complex applications, even via feasibility studies. We develop accurate work processes, draw with FEM analyses to verify our mechanical-structural performance and optimise the manufacturing process of each component.

Ready To Deliver

A well-stocked and complete warehouse of finished products enables Maus Italia ship quickly to customers all over the world according to a ready-to-deliver logic.

The warehouse is fully located within our premises in Bagnolo Cremasco at controlled temperatures and conditions to guarantee the maximum safety and quality of Maus Italia products for all our customers.

Quality, environment and safety policy

Research, quality and safety are the watchwords of Maus Italia Spa.

Maus Italia has several projects underway aimed at increasingly sustainable development and integrates environmental concerns into its business model. The company's actions, behaviour and development choices are focused not only on the short run but rather mainly on a medium and long-term horizon.



Every day in over 80 country worldwide

Find an official distributor in your country



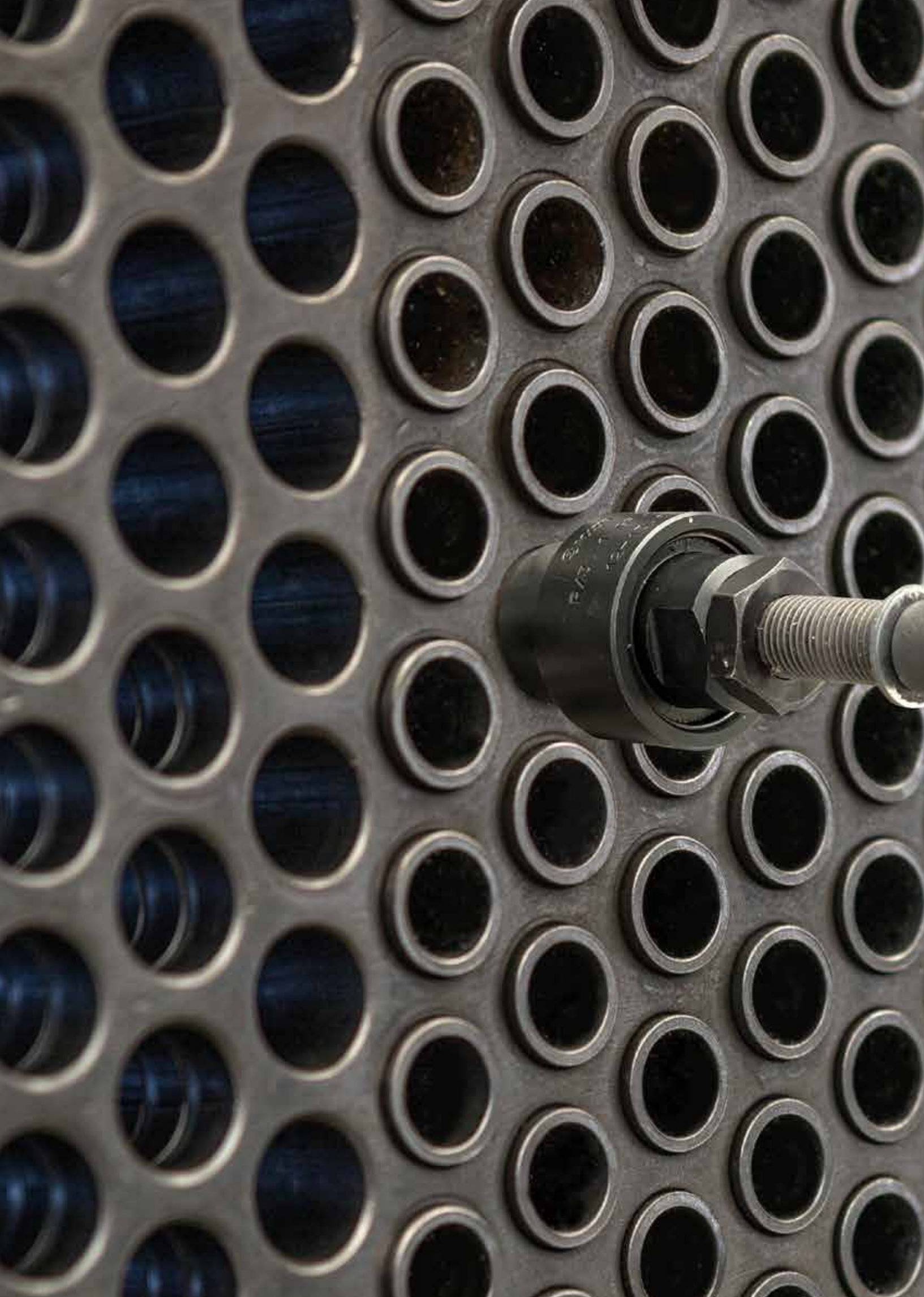

Portrol 401

Portable electrical equipment for the controlled rolling of tubes with an external \varnothing diameter from 1/2" up to 1.3/4" (from 12,7 to 44,4 mm)

For quality work where maximum portability is required

Maus Italia presents the Portrol 401, extremely easy to handle with a high level of quality.

Easy to move with its own wheeled case, the Portrol 401 and the 400 Volt-triphas PR1000 tube roller ensure a fast system setup and short time for working parameter programming via its display interface.



400 V three-phases system



Portable



Value for money



Easy to move



Standard supply

- Portable controller Port401
- PR1000 Series tube rolling motor
- Quick coupling F314HS-3/8" or F314HS-1/4"
- Remote magnetic emergency stop button
- Instruction manual
- 2No. wheeled cases for moving

Port 401

Portable electronic controller for the rolling of tubes

Designed to be used in conjunction with PR1000 series rolling motors it is compact and lightweight. Thanks to the integrated SIEMENS TDE panel with LED backlighting, programming of parameters is quick and easy.

User friendly

Repeatability $\pm 5\%$

Advanced functionality with display

High quality



Operator panel with display

The SIEMENS® TDE control panel ensures the controller's practicality and efficiency. Access to all parameters by operators is extremely easy.

Stop / Emergency button



Main switch

Start / reset button

Rolling motors balancer button

Used in combination with a dead man's button on the tube roller during the initial calibration and zeroing of the rolling torque.

Operator panel with display

Display of the work phases:
Stop / Working / Return

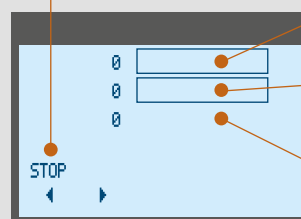

Display programmed torque value
Real time display torque value during operation
Display last torque value reached

F1

F2

Increase expansion torque

Reduce expansion torque

PR 1000

Portable electric 400 V
Three-phases rolling motors

Designed to be used in combination with the Port 401 electronic controller .

Thanks to its external PVC casing, as well as being extremely robust, it also complies with strict insulation standards. Proposed for the rolling of tubes, it can also be used for cutting and end-facing tubes.

Reliable

Robust



F314HS

Double female quick coupling fitting for high speeds



CE

Class II Double insulation

In accordance with the European technical standards on safety of portable power tools:
EN 60745-1 • EN 60745-1/A1
EN 60745-2-1 • EN 60745-2-2



NO VIBRATIONS

Optional



TPB-3A

Optional balancer for weights from 10 to 14 kg (da 22.0 a 30.86 Lb)

Porter basic

Optional carriage for support of the tube rolling motors machine

Red button

"Stop" - dead man's button



Black button

Reversal of the rotation of the motor and the consequent release of the mandrel at the end of the expansion

Green button

"Start"

Technical features

Port 401

Power supply

Voltage - phase	300 Volt (415-3 Ph)
Max ampere	2,5 A
Frequency	50/60 Hz
Absorbed power	1,0 Kw/A

Dimensions

Lenght (depth)	A	450 mm (17.7 inches)
Width (with handle)	B	420 mm (16.5 inches)
Height	C	210 mm (8.3 inches)
Weight		13 Kg (28,7 Lb)
Level of protection		IP 32
Chassis colour		7030 - 7035 RAL

Shipping

Size	53x70x30 cm (1.74x2.30x0.98) inches
Total weight	22 Kg / 48.50 lb

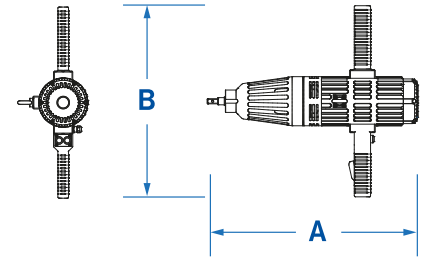
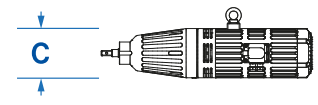
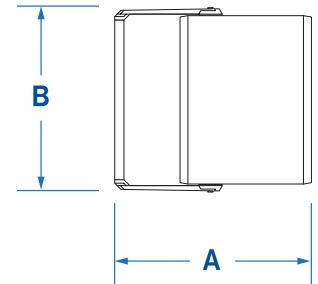
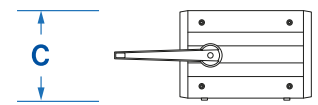

PR 1000

Model

		PR1000-4	PR1000-5	PR1000-7	PR1000-10	PR1000-15
Speed	Rpm	750	600	430	300	200
Max torque	Nm - Ft Lbs.	12 (8.85)	15 (11.06)	22 (16.22)	30 (22.12)	40 (29.50)
Tube max ø (ext) - Ferrous	mm / inches	12,7 (1/2")	19,0 (3/4")	22,2 (7/8")	25,4 (1")	31,8 (1.1/4")
Tube max ø (ext) - Non Ferrous	mm / inches	19,0 (3/4")	22,2 (7/8")	31,8 (1.1/4")	38,1 (1.1/2")	44,4 (1.3/4")
Supplied fittings		F314 HS-3/8"	F314 HS-3/8"	F314 HS-3/8"	F314 HS-3/8"	F314 HS-1/2"
Power supply						
Motor voltage	Volt - Ph	400-3	400-3	400-3	400-3	400-3
Frequency	Hz	50	50	50	50	50
Power	Kw	1,0	1,0	1,0	1,0	1,0
Dimensions						
Lenght	mm / inches	480 (18.9)	480 (18.9)	480 (18.9)	480 (18.9)	480 (18.9)
Width (with handles)	mm / inches	450 (17,7)	450 (17,7)	450 (17,7)	450 (17,7)	450 (17,7)
Height (without eyebolts)	mm / inches	115 (4.5)	115 (4.5)	115 (4.5)	115 (4.5)	115 (4.5)
Weight	Kg / Lbs.	9,5 (21)	9,5 (21)	9,5 (21)	9,5 (21)	9,5 (21)
Level of protection	IP	32	32	32	32	32
Colour		Black	Black	Black	Black	Black
Shipping						
Size	cm / ft	53x70x30 (1.74x2.30x0.98)				
Total weight	Kg / lb	21 (46.30)				

50Hz

Available also for frequency of 60Hz (approx +20% of speed - approx -20% of torque) *

60Hz

F314HS

Dimensions

F	inches
Weight	Kg (lb)
Colour	

F314HS-1/4"

1/4"
0,18 (0.40)
Black

F314HS-3/8"

3/8"
0,21 (0.46)
Black



TPB-3A

Work capacity

Supported weight	Kg (lb)	10 (22.0)
Y axis - vertical stroke	Y mm (inches)	2500 (98.5)

Dimensions

Diameter	mm (inches)	180 (7.1)
Width (thickness)	mm (inches)	90 (3.5)
Weight	Kg (lb)	3,5 (7.7)
Colour		Silver - Black

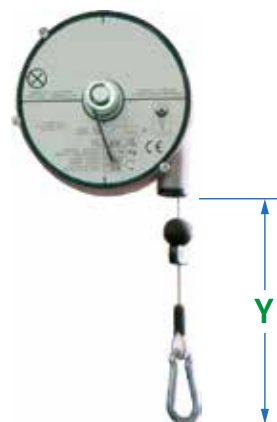

Porter basic

Work axes

X axis	X	Movement	Manual sliding
Z axis	Z	Movement	Manual sliding

Work capacity

Supported weight	Kg (lb)	40 (88.0)
------------------	---------	-----------

Dimensions

Lenght (depth)	A	mm (inches)	1200 (47.2)
Width	B	mm (inches)	1600 (63.0)
Height	C	mm (inches)	2600 (102.3)
Weight		Kg (lb)	70 (155)
Colour			Anodised aluminium

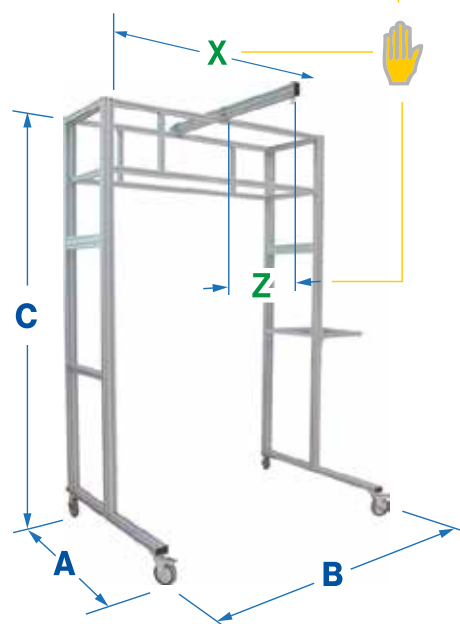

Heat exchanger's world

MAUS ITALIA SPA IS THE WORLD LEADING MANUFACTURER OF TOOLS AND MACHINES FOR THE PRODUCTION AND MAINTENANCE OF HEAT EXCHANGERS



Maus Italia S.p.A.

SP 415 KM 30 (nuova strada di arrocco)
26010 Bagnolo Cremasco (CR) Italy
PIVA: 00141010199

Telefono: +39 0373 2370

expo@mausitalia.it
www.mausitalia.it





mausitalia.it

